

Name : _____

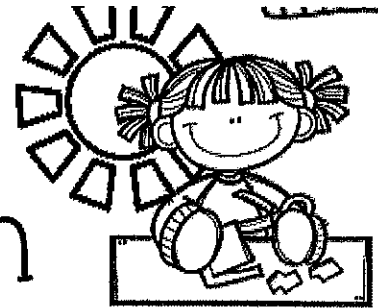
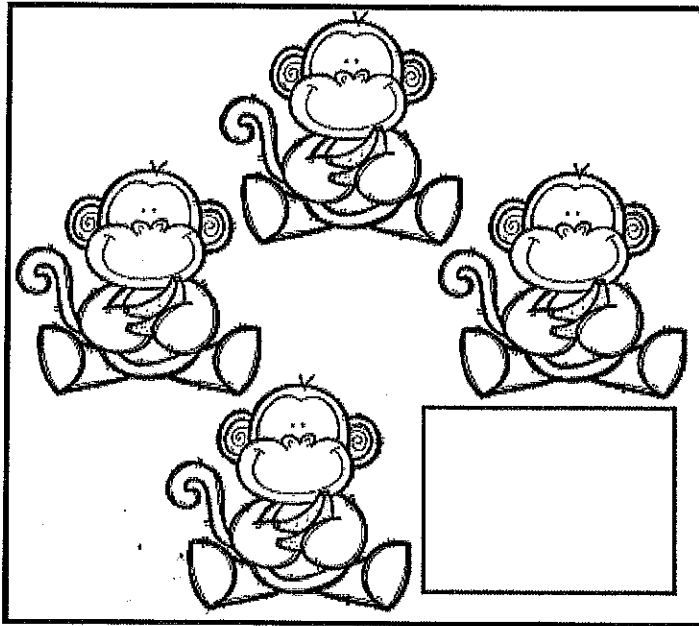
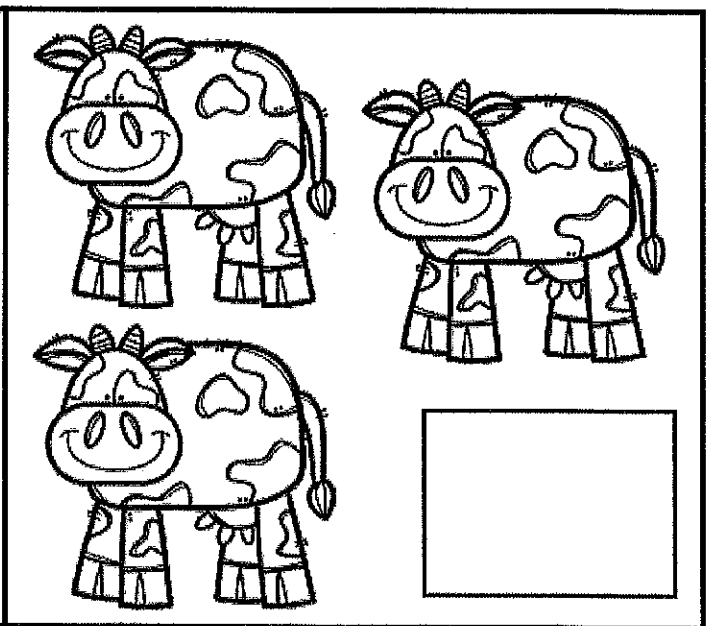

Count and match

Count the items in each box. Cut and paste the number into the correct box.

 <input type="text"/>	 <input type="text"/>
------------------------------------------------------------------------------------------------------------	-------------------------------------------------------------------------------------------------------------

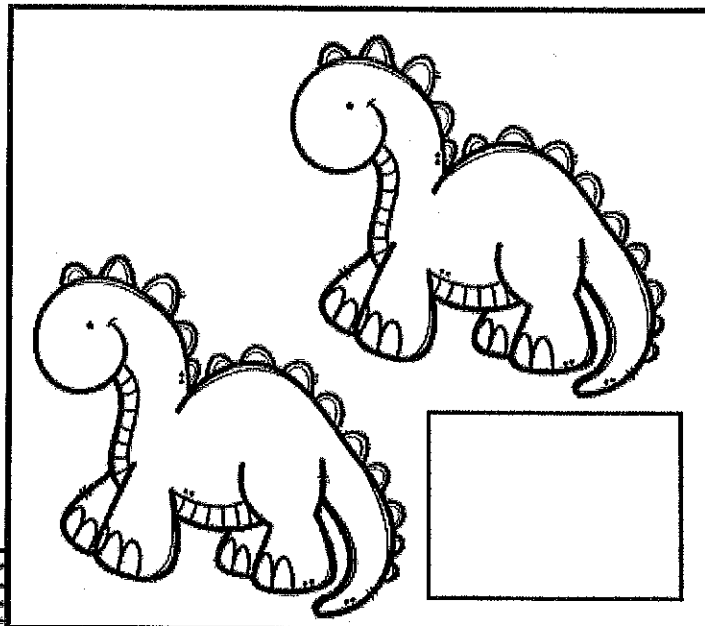
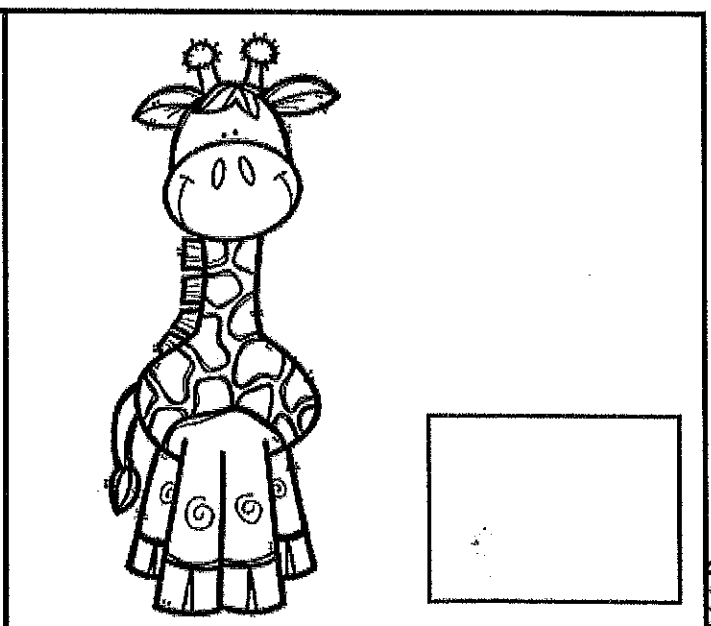
 <input type="text"/>	 <input type="text"/>
-------------------------------------------------------------------------------------------------------------	--------------------------------------------------------------------------------------------------------------

© Miss Faleena

2 4 3 1

Name : _____

Comparing Numbers

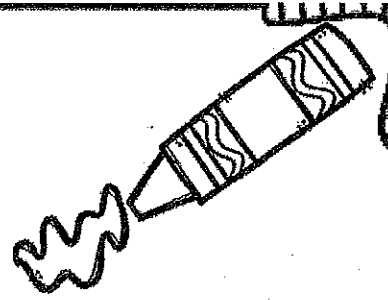

Color the larger number.

3

6

2

8

8

5

7

10

1

2

5

7

10

8

9



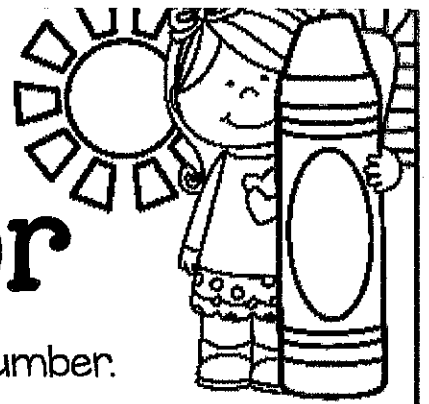

2



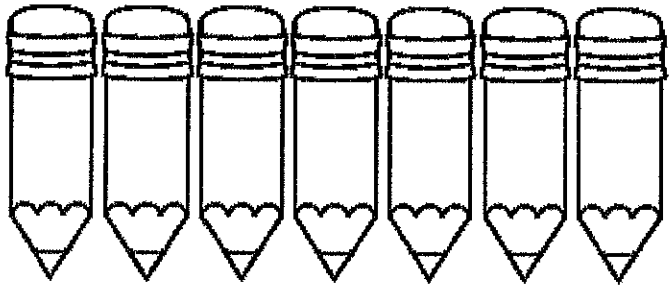

Name : _____





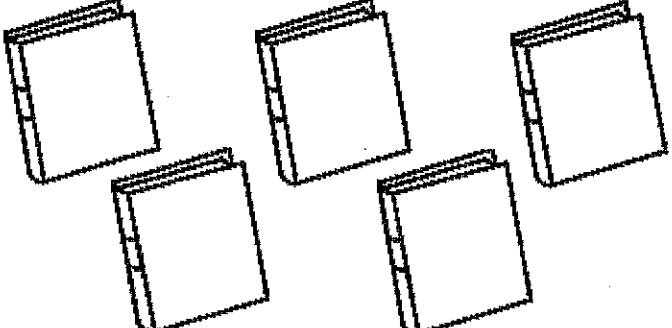

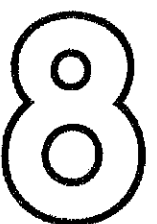
Count and Color

Count the items in each row and color the correct number.

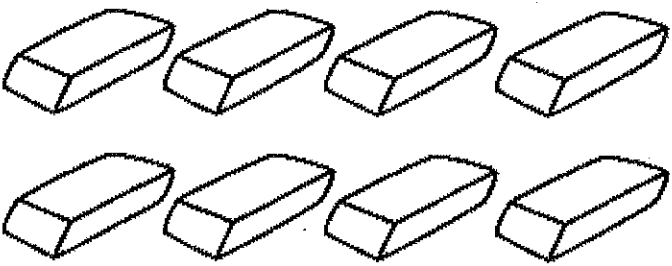
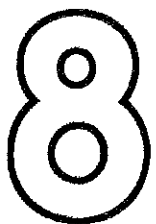
			
-----------------------------------------------------------------------------------	-----------------------------------------------------------------------------------	-------------------------------------------------------------------------------------	-------------------------------------------------------------------------------------

			
------------------------------------------------------------------------------------	------------------------------------------------------------------------------------	--------------------------------------------------------------------------------------	--------------------------------------------------------------------------------------

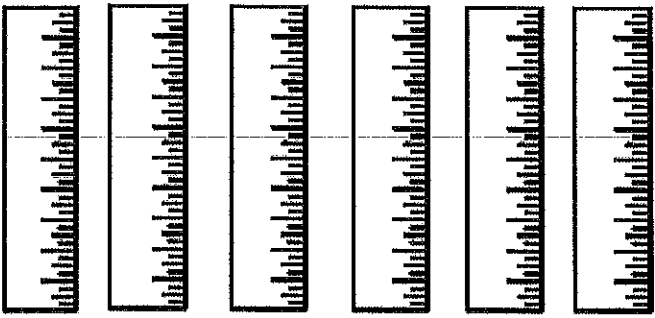
			
-------------------------------------------------------------------------------------	-------------------------------------------------------------------------------------	---------------------------------------------------------------------------------------	---------------------------------------------------------------------------------------

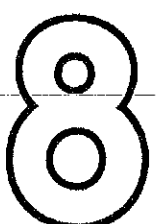
			
-------------------------------------------------------------------------------------	-------------------------------------------------------------------------------------	---------------------------------------------------------------------------------------	---------------------------------------------------------------------------------------

Name: _____

Missing Letters - School Theme - by Lavinia Pop © 2013



Cut and paste the missing letters in the correct squares.



a		c		
d	e			
	h	i		k
l		n	o	
	r		t	u
v		x		z

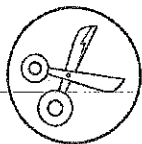

q p g j s
f w y m b

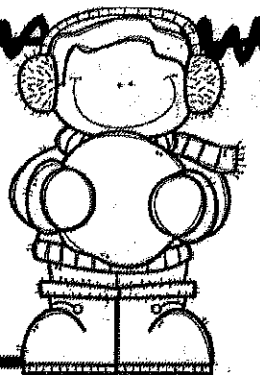

Name: _____

10 Frames

1. Color 8 snowflakes.

2. Color 1 carrot.

3. Color 2 earmuffs.

Name _____

Subtraction Fluency

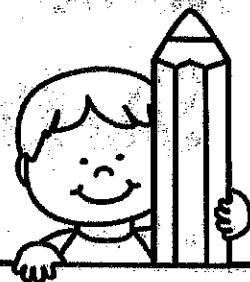

Subtract. Write the answer.

$4 - 0 = \underline{\quad}$

$5 - 3 = \underline{\quad}$

$3 - 1 = \underline{\quad}$

$4 - 2 = \underline{\quad}$

$5 - 2 = \underline{\quad}$

$2 - 0 = \underline{\quad}$

$2 - 1 = \underline{\quad}$

$4 - 1 = \underline{\quad}$

$5 - 1 = \underline{\quad}$

$3 - 2 = \underline{\quad}$

Name: _____

10 Frames

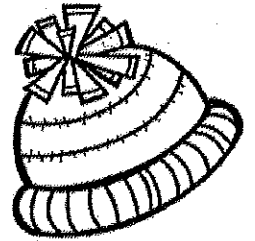

1. Color 9 hats.



2. Color 10 snowflakes.

3. Color 4 boots.

Name: _____

Date: _____

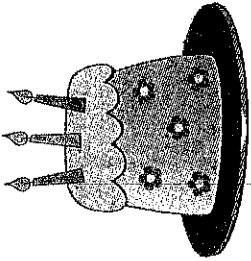
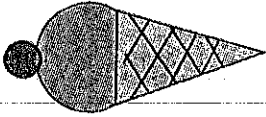
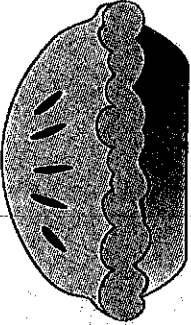
Copy It!

	Cake	Cake	_____
	Ice Cream	Ice Cream	_____
	Pie	Pie	_____
	Cookie	Cookie	_____

Tracing Number 1-5

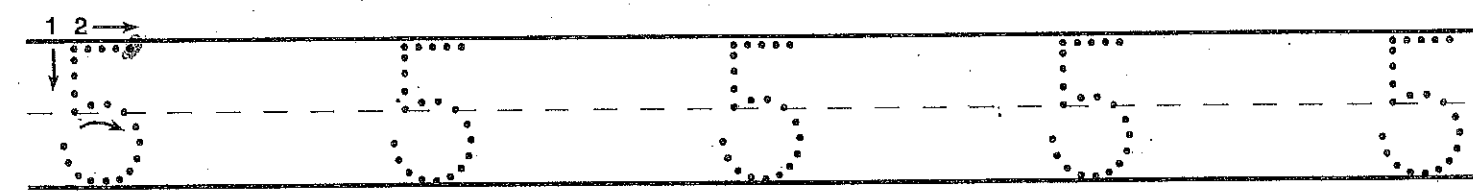
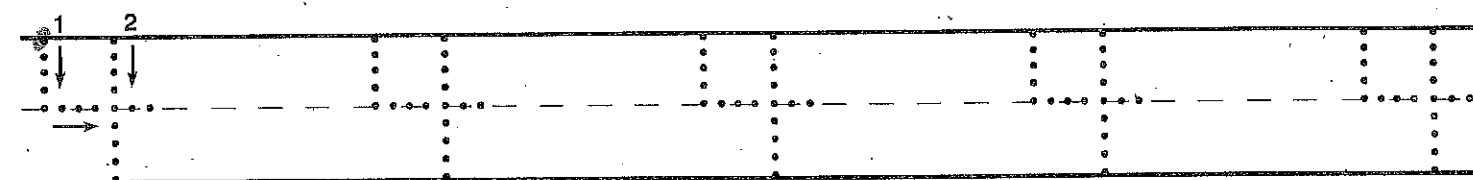
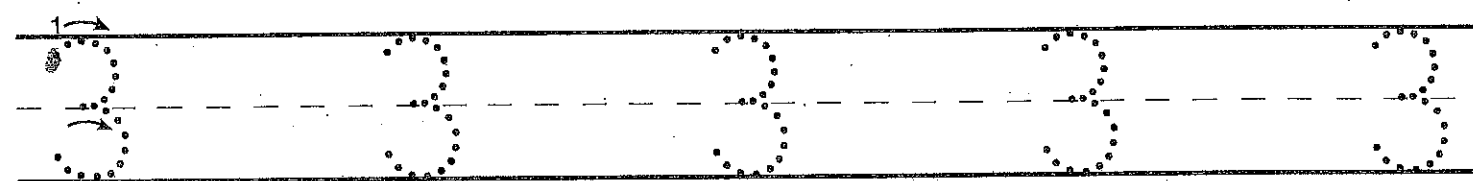
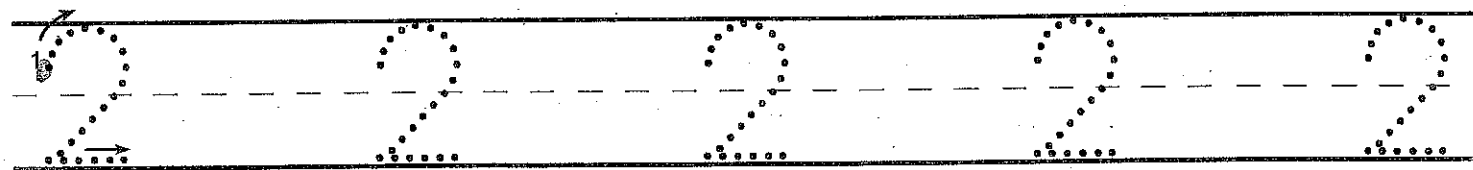
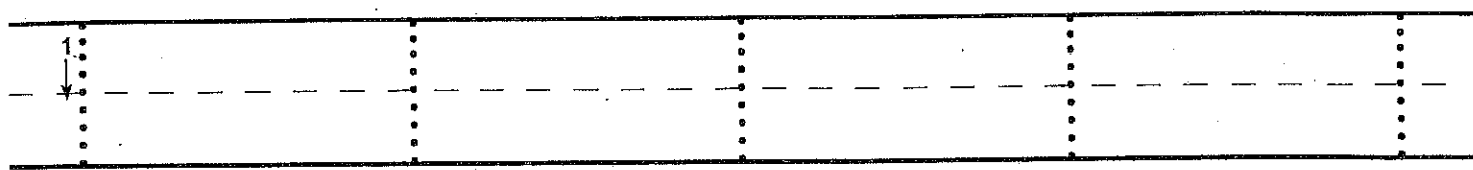

Name _____

Name: _____



Cut and paste the missing letters in the correct squares.

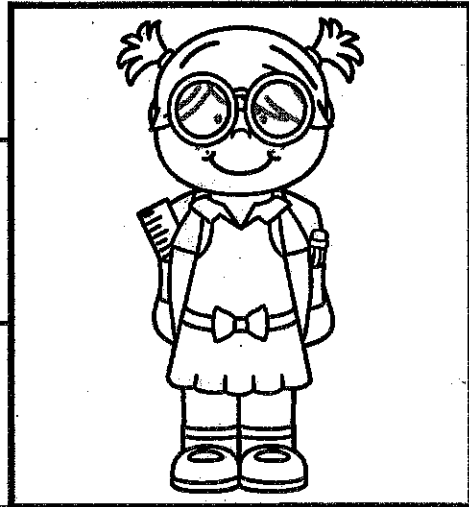

A		C		
D	E			
	H	I		K
L		N	O	
	R		T	U
V		X		Z

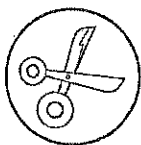

Q	P	G	J	S
F	W	Y	M	B

Name _____

Subtraction Fluency



Subtract. Write the answer.

$2 - 1 = \underline{\quad}$

$5 - 0 = \underline{\quad}$

$3 - 2 = \underline{\quad}$

$4 - 4 = \underline{\quad}$

$5 - 5 = \underline{\quad}$

$2 - 2 = \underline{\quad}$

$5 - 1 = \underline{\quad}$

$4 - 3 = \underline{\quad}$

$4 - 1 = \underline{\quad}$

$4 - 2 = \underline{\quad}$

Name _____

Add Within 5

Addition Fluency

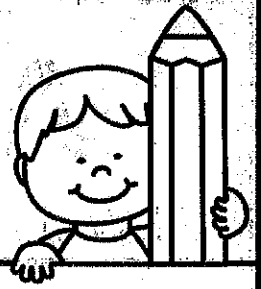

Add. Write the answer.

$$2 + 1 = \underline{\quad}$$

$$2 + 3 = \underline{\quad}$$

$$3 + 0 = \underline{\quad}$$

$$1 + 1 = \underline{\quad}$$

$$2 + 0 = \underline{\quad}$$

$$0 + 5 = \underline{\quad}$$

$$1 + 3 = \underline{\quad}$$

$$3 + 1 = \underline{\quad}$$

$$1 + 4 = \underline{\quad}$$

$$4 + 0 = \underline{\quad}$$

ne:

10 Frames

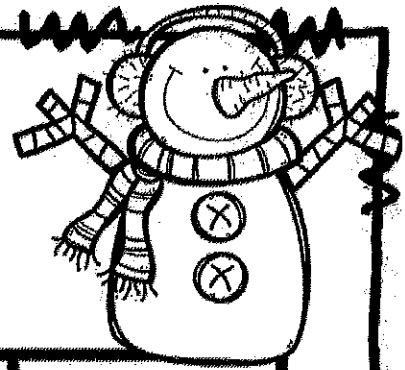

1. Color 1 square any color.

2. Color 4 squares any color.

3. Color 10 squares any color.

Name: _____

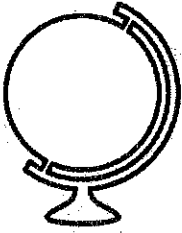
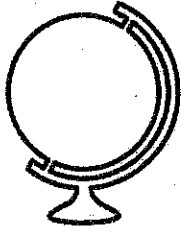
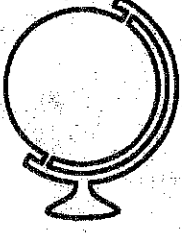
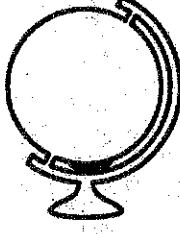
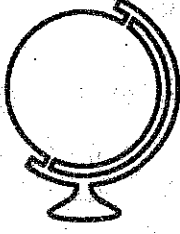
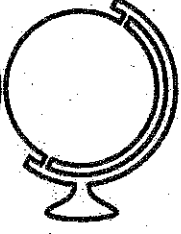
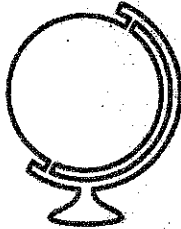
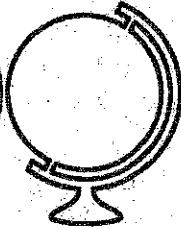

Write the missing letters:

a	b	c		e		g
	i		k	l	m	n
o	p	q	r			u
v			y	z		



Cut and paste the missing letters in the correct squares.

l			o	p
	r		t	

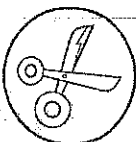

q	u	n	s	m
----------	----------	----------	----------	----------